

DONE DECK Installation & Maintenance Guide

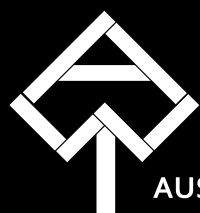

AUSTRALIAN WOOD INDUSTRIES.

DONE RIGHT



The DONE Difference

DONE DECK timber products are factory pre-oiled for 360° Protection which eliminates the hassle of oiling timber pre-installation, saving both money and time on labour and material costs.

DONE DECK is seasoned and further kiln dried to the moisture requirements of Australian Standard AS2796 of 10% to 18% and features our signature **DONE** finish, a super smooth finish which is a result of our precision milling techniques coupled with pencil round edges that reach a variety of widths. This makes **DONE DECK** the perfect material for timber decking, pergolas, verandas, screening, fencing, seating and gates. **DONE DECK**'s premium quality also makes **DONE DECK** the ideal timber for surrounding swimming pools. Once installed our **DONE DECK**'s pre-oiled formula is suitable to be re-coated with your preferred oil or water based decking protection*.

*Can not be coated with CUTEK. Must be coated and maintained with Intergrain Universal Oil to take advantage of the **2 YEAR WARRANTY**

DONE DECK timber is available in:

Blackbutt

Spotted Gum

Tallowwood

Silvertop Ash

Fijian Mahogany

Merbau

... other species are available on request

"DONE DECK is made for those builders who like to get it **DONE RIGHT** without losing time or money."

**2 YEAR
WARRANTY**

Make sure your install is **DONE RIGHT** & Register at australianwood.com.au to receive a **2 YEAR WARRANTY***

DONE DECK

Installation Guide



This installation guide outlines the recommended method of installing timber decking over bearers and joists. Please note that individual conditions can vary from within this guide and it is advised to seek independent professional advice before you start any commercial work. We highly recommend to check with state and local authorities to ensure that you meet your required building compliance. This includes making your own and/or seeking an independent professional assessment of the relevant applicable laws and standards.

Construction of the sub frame including post sizes, stress grades of members including bearers and joists, spans of members and any other structural elements relevant to building a deck must conform with Australian Standards AS1684: Residential Timber-Framed Construction and AS1720: Timber Structures - Design Methods. All building codes and Australian Standards need to be adhered to when building a deck. This installation guide does not apply to specialty applications or commercial decking. For specification and design of commercial or industrial applications refer to Australian Standards AS1170: Dead and Live Loads and Load Combinations. Building a deck in bush-fire prone areas may also require adherence to Australian Standard AS3959: Construction of Buildings in Bush Fire Prone Areas.









Installers are advised to check with the local council about the relevant regulations prior to installation.



How to Store DONE DECK

If installation is not going to take place immediately, **DONE DECK** products need to be stored on a flat surface that is undercover and protected from the elements. **DONE DECK** is pre oiled with Intergrain Universal Timber Oil for 360 degree protection however, the timber can be subject to damage due to the natural elements, especially if stored over a long period of time. Storage must address environmental factors such as relative humidity, moisture ingress, exposure to weather, lack of protective coatings/covers or lack of adequate ventilation under the timber. Prior to storage, please make sure that all boards are checked in case of possible transportation damage.

Safe Work Practises

| | |
|---|---|
|  HEAD PROTECTION |  RESPIRATORY PROTECTION |
|  HEARING PROTECTION |  GLOVES |
|  LONG SLEEVES, |  EYE PROTECTION |
|  BOOTS |  PANTS |

When dealing with any type of construction project, it is necessary to wear appropriate safety equipment to avoid risk of injuries. We recommend the following safety equipment when handling, cutting, and installing **DONE DECK**: gloves, respiratory protection, long sleeves, pants, hearing and eye protection all should be worn. Work environment must be clean and a smooth, flat and strong surface is needed to install **DONE DECK** correctly. Sawing, sanding, and routing equipment should be fitted with dust extractors. Dust levels should be below standards set by Safe Work Australia for wood dust. After handling timber, wash skin thoroughly with mild soap and regularly wash clothing. For any treated timber, do not burn offcuts or sawdust. Preservative treated offcuts and sawdust should be disposed of by approved local authority methods.

Please check with local building codes before installing this type of decking

Pre Planning Requirements

For the best results it's recommended to plan a layout of the decking before installation. Building codes and zoning regulations generally apply to permanent structures, which includes anything that is anchored to the ground or attached to the building. We recommend drawing out a site plan of your proposed project to minimise errors and achieve the best outcome. **DONE DECK** requires adequate cross flow ventilation above and below the deck and it's also recommended that **DONE DECK** be installed at least 400mm above the ground to guarantee optimal performance and ventilation.

GAPS & SPACING FOR DECKS > 400mm Ground Clearance

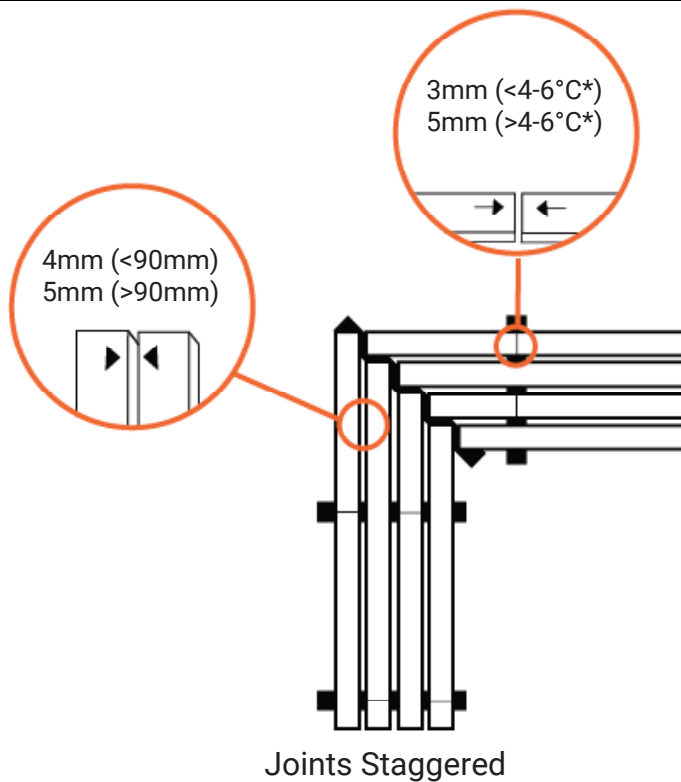

*Temperature at installation

ACCESSORIES DONE RIGHT

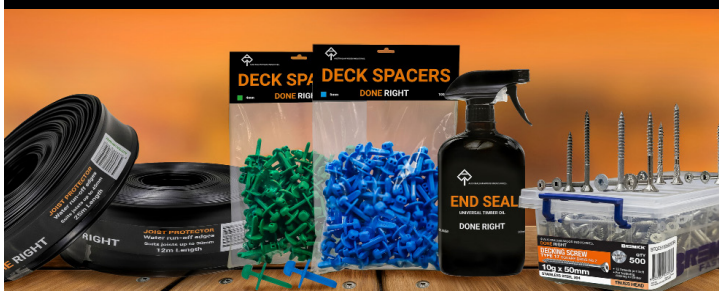

Screws at opposing angles or offset

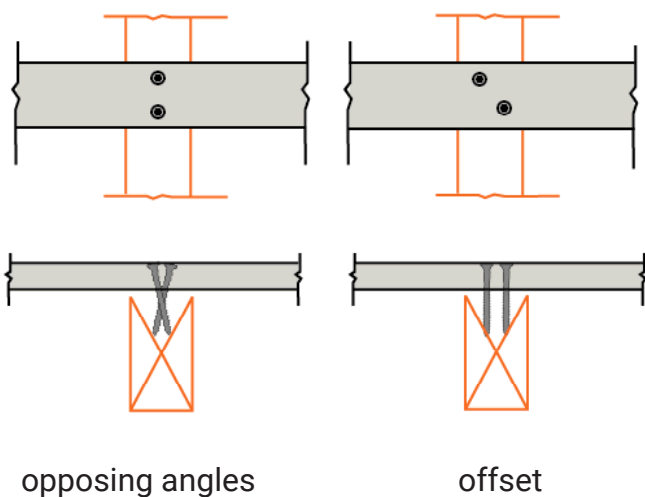

Predetermine your deck dimensions and note the position of features such as stairs, drains, and pipes as these will need to be marked up before any work begins. It is important to have a clear ground and that weed control is **DONE** before installing the deck. Adequate drainage is a must to avoid a build-up of water underneath the deck. Unobstructed air flow is needed below the deck and additional vents are required in areas of limited ventilation. To allow for offcuts and joining boards over joists a 10% waste factor is considered standard industry practice. **DONE DECK** is graded as per AS2796 to one face of the decking board only.

Plan to leave a sufficient gap to allow the decking to expand and contract during seasonal variation. 135 mm wide boards will expand approximately 0.5 mm for every 1% increase in its moisture content. During winter, the increase in moisture content can be up to 4-6% so each board could expand 2-3 mm. We recommend gaps for boards up to 90mm wide use a minimum gap of 4mm and for boards over 90mm wide use a minimum gap of 5mm. Close to ground decks (under 400mm) require an 8mm gap between boards regardless of board width. Bushfire zones may have specific gapping requirements. Use **DECKING SPACERS DONE RIGHT** for a fast even gap through out your deck.

All decks must have good sub deck and cross flow ventilation. Solid perimeter walls should be avoided as a damp sub deck will cause the bottom of the boards to take up moisture and cup. If solid perimeter walls are unavoidable specially designed vents are required. Install **JOIST PROTECTOR DONE RIGHT** over the top of the joists and under the decking to keep joists dry and limits the chance of rotting.

If installing near salt water, a swimming pool, or an areas exposed to weather, it is highly recommended to use stainless steel or silicon bronze fixings. Predrilling is recommended prior to installation for screws. At intermediate fixings, screws should either be offset or driven at slightly opposing angles.

Installation Requirements

DONE DECK was created for bearers and joists that are structurally sound and AS1720 compliant with the National Construction Code (NCC).

Decking should be screwed with AUSTRALIAN WOOD INDUSTRIES' **DECKING SCREWS DONE RIGHT** directly to bearers and joists. If you want to use **DONE DECK** for fencing it can be screwed into timber or steel posts. Installation standards for decking products is outlined in the AS1684 and AS1720.

Always adhere to all NCC regulations, local council and building authority requirements and determine if the decking product you are using is fit for your intended purpose. Please seek independent professional advice should you have any concerns.

Undercut For Flush Finish To Joist

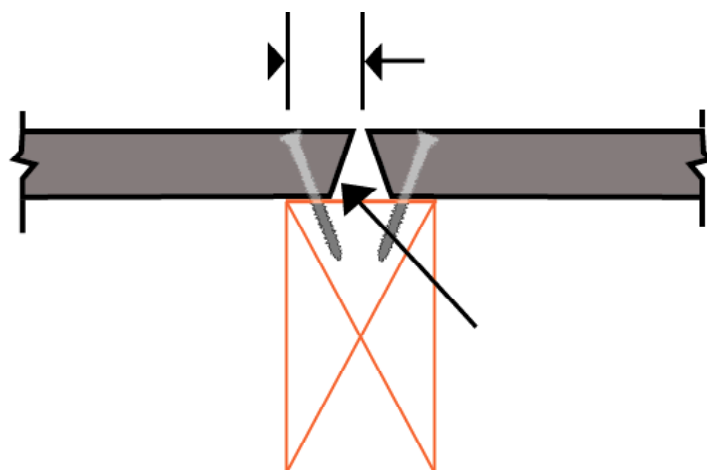

IMPORTANT: Cut ends and undercuts must be sealed with END SEAL DONE RIGHT prior to installing.

Cutting and Fastening DONE DECK

To obtain a tight fit on the joints, a slight undercut will assist with the boards sitting flush (Graph 1.3). To facilitate the decking screws, a pilot or countersink hole, 80% of the screw diameter should first be drilled. This will reduce stresses during seasonal movement changes in the deck and should limit the chances of boards cracking and splitting. Screws must be kept 12mm from edges and ends of boards. Screws must be driven flush with surface (not punched). Each board should be screwed to each joist with two screws as required by Australian Standard AS1684 for required fixings for domestic decking. Alternatively, proprietary fixing systems may be used in accordance with manufacturer's instructions. Take care when using machines to ensure that the screw head is not driven below the surface of the board. Types of screws are generally proprietary information and reference to the manufacturer's installation requirements should be followed. Alternatively, proprietary fixings such as concealed fixing systems may be used in accordance with manufacturer's guidelines.

Close to water or ground decking

Performance of the wooden deck near the ground or within 1m of water cannot be guaranteed. When planning to build a deck less than 400mm from the ground or within 1 metre of a pool the decking needs increased ventilation, fastener durability considerations, durable timber species selection, more frequent re-coating and maintenance, access for termite inspection, and subsurface drainage. Meteorological Conditions such as but not limited to excessive rain, hot sun and winds can also affect deck functioning.

We recommend applying the following installation practices when installing close to the ground or pools. When installing timber close to water or close to the ground it is highly susceptible to above average expansion, contracting, cupping, and warping of the decking boards. The use of thinner boards 64-90mm is recommended in these situations and an 8mm gap between the boards is essential to assist with increasing the airflow between and beneath the boards. It is also necessary to apply additional coats all sides of the boards before install including the underside and ends.

Tannin Stains

Whenever moisture leaves the timber, tannin stains can show up as a result water soluble extractives found in most hardwoods. These tannin stains can be complicated to get rid of especially from unsealed masonry surfaces. The best way reported to keep this tannin bleed away is to coat all sides of the timber with a suitable finish.

Finishing Your DONE DECK

Now that your DONE DECK is installed, it's time to finish the job. Applying finish coats and adhering to the correct care and maintenance program, will see that your deck will get a long lifespan and a great look.

Deck Finishes

It must be thoroughly swept and cleaned to remove metal filings from drilling or other construction that may cause black spots. If the deck has turned grey from natural weathering or is discoloured due to metal filings or other construction materials, there is a large range of maintenance and cleaning products from your local Mitre 10 or Home Hardware which may help bring it back to its natural beauty. We recommend thoroughly scrubbing with Intergrain UltraPrep Timber Cleaner. Once dry apply finish coats of Intergrain Universal Oil as specified by the product application instructions. Whilst **DONE DECK** is capable of being finished in almost any oil or water-based finish (excluding Cutek), to be eligible for the **2 YEAR WARRANTY** you will need to apply and maintain your **DONE DECK** with Intergrain Universal Oil.

Coating DONE DECK in Intergrain Universal Oil will provide an outstanding finish and excellent protection.

Deck Care and Maintenance

Your new DONE DECK should be regularly cleaned with a broom or blower. Damaged boards should be rescued as soon as you notice them.

Twice per year (possibly more, dependent on the local environment) you must conduct a maintenance session on your DONE DECK. The deck should be thoroughly scrubbed with Intergrain UltraPrep Timber Cleaner and multiple coats of your existing finish should be reapplied. This process is important to ensure your coating is still repelling water and the finish is in a sound condition.

Avoid hosing the deck and never use a pressure washer.

DONE DECK

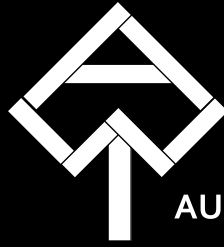

AUSTRALIAN WOOD INDUSTRIES.



Phone :
1300 333 294



E-Mail :
sales@australianwood.com.au



Address :
Unit 1/18 Shale Pl
EASTERN CREEK NSW 2766

V:202309